

SOFT BED

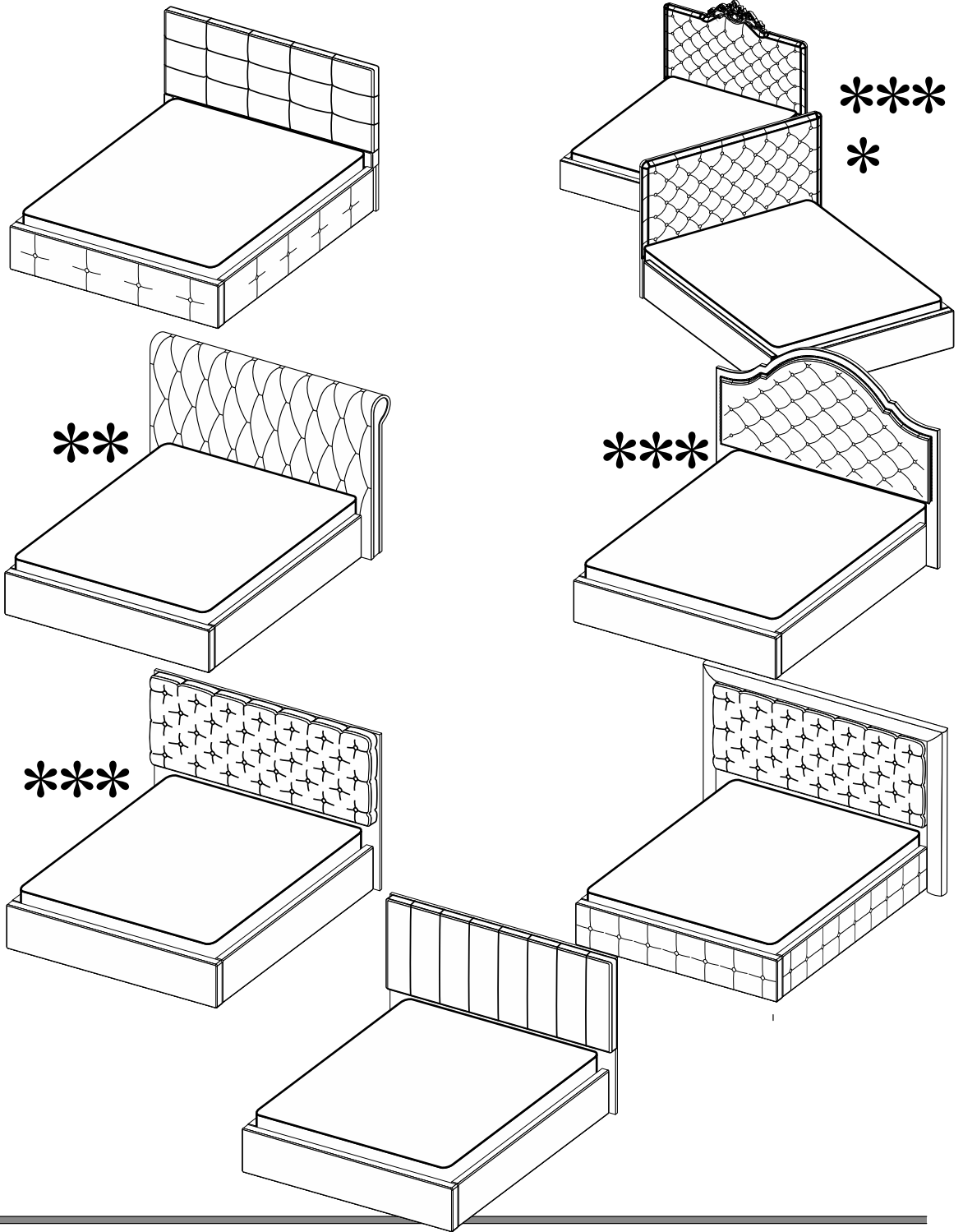

T

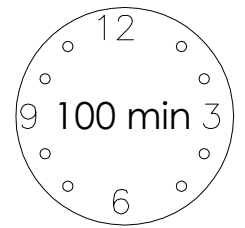
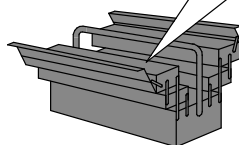
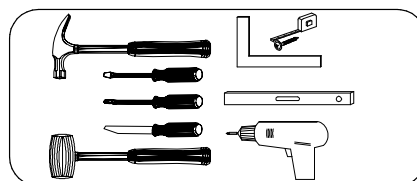
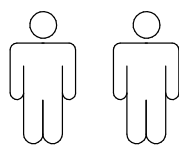

1

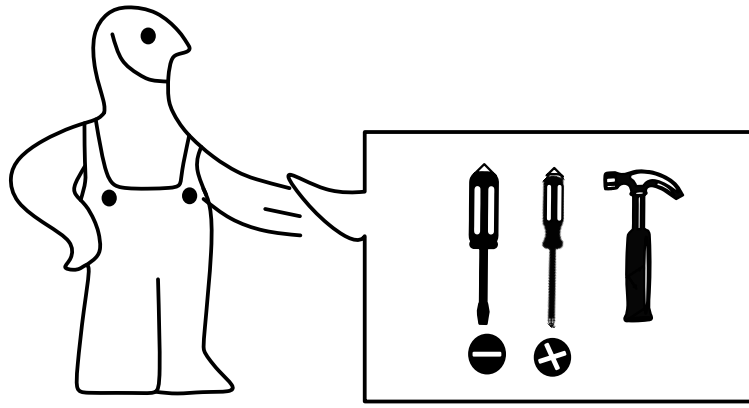

2

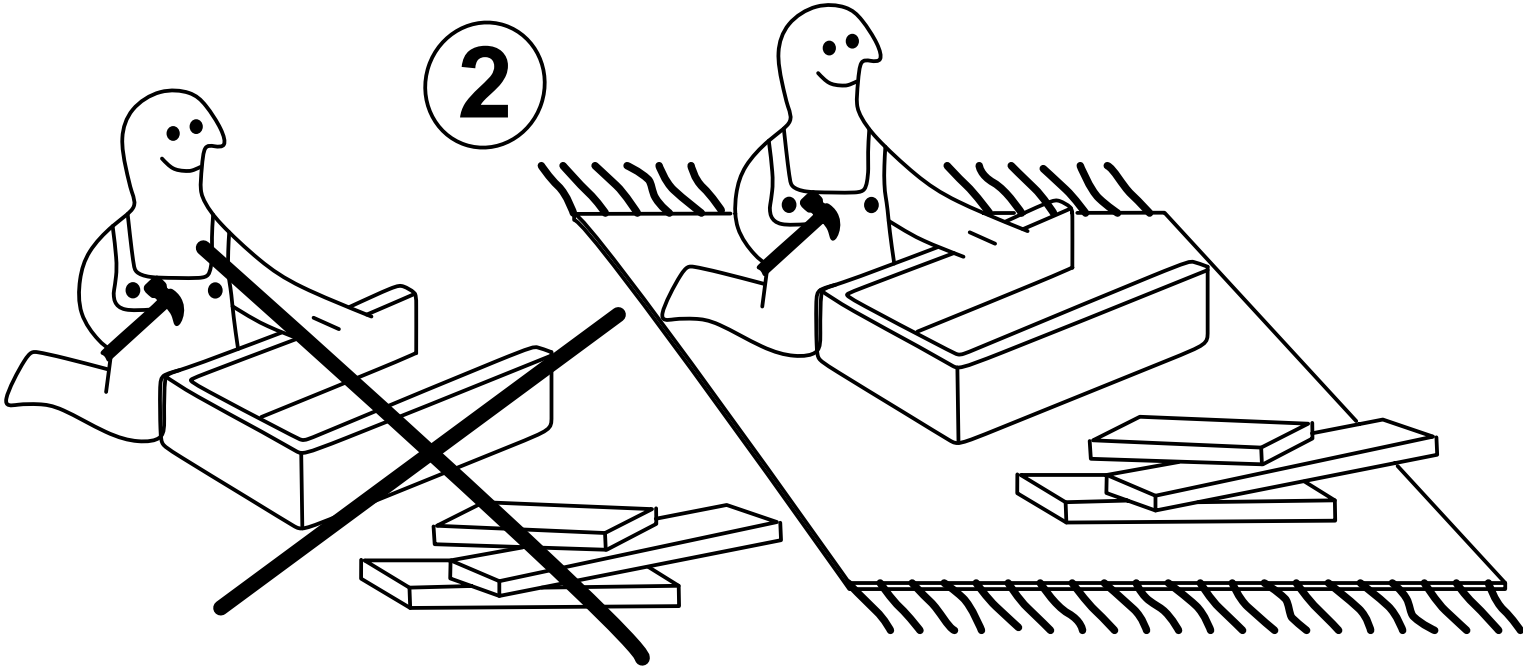

3



4

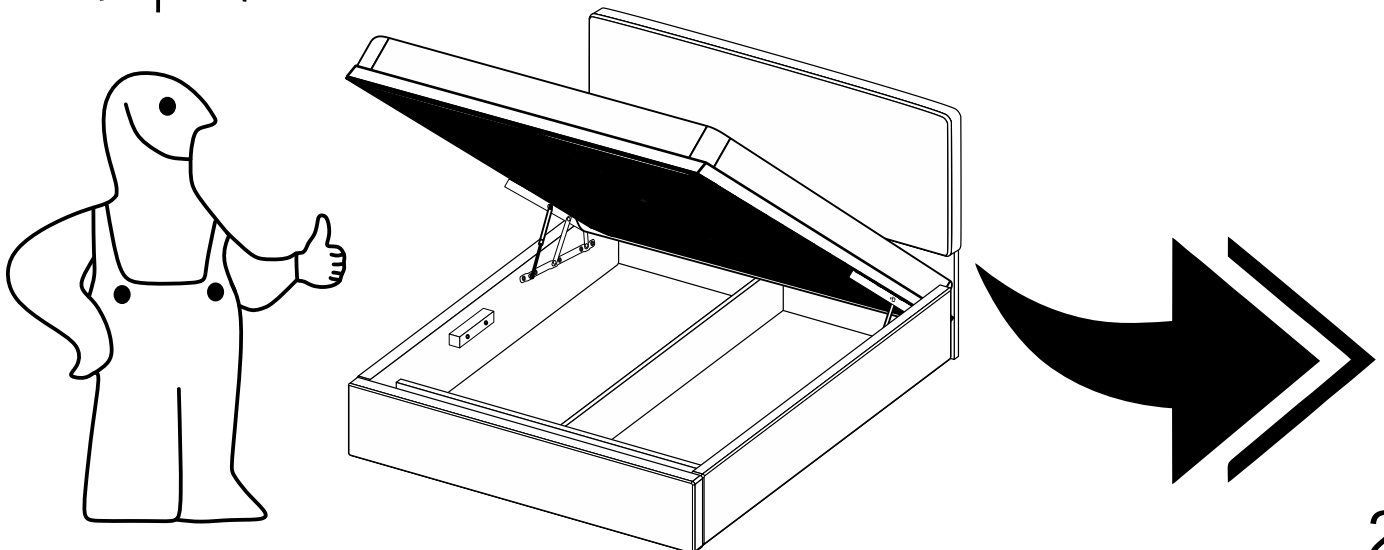

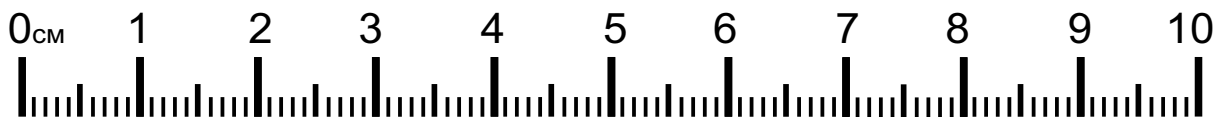
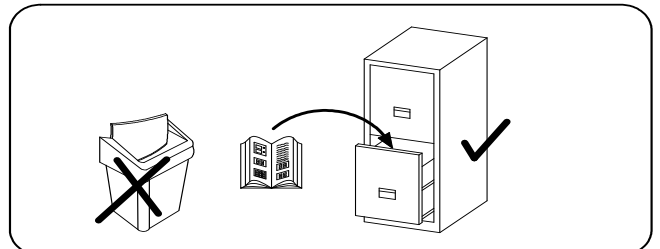
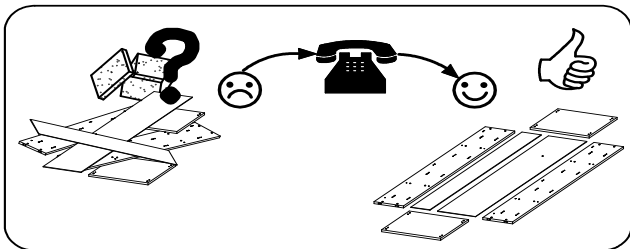
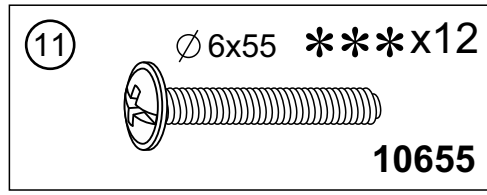
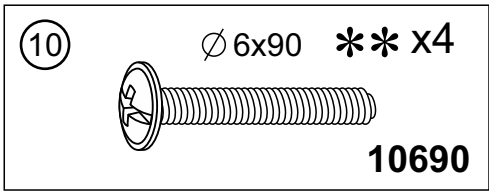
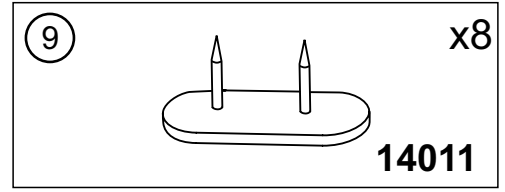
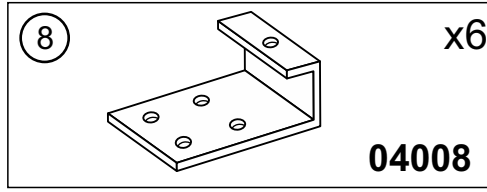
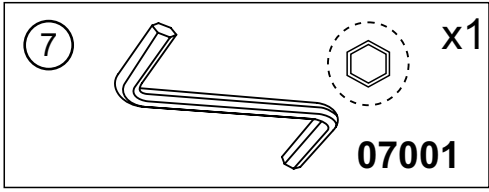
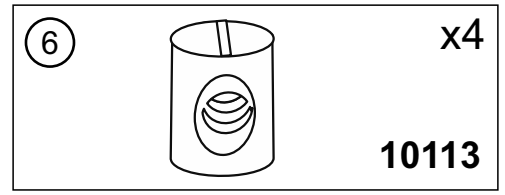
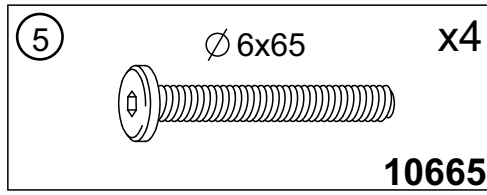
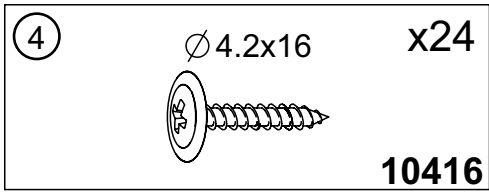
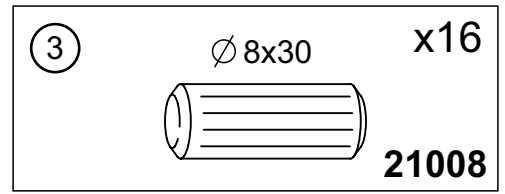
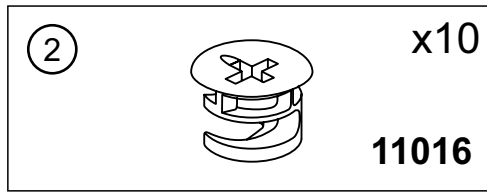
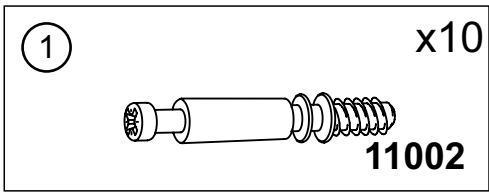

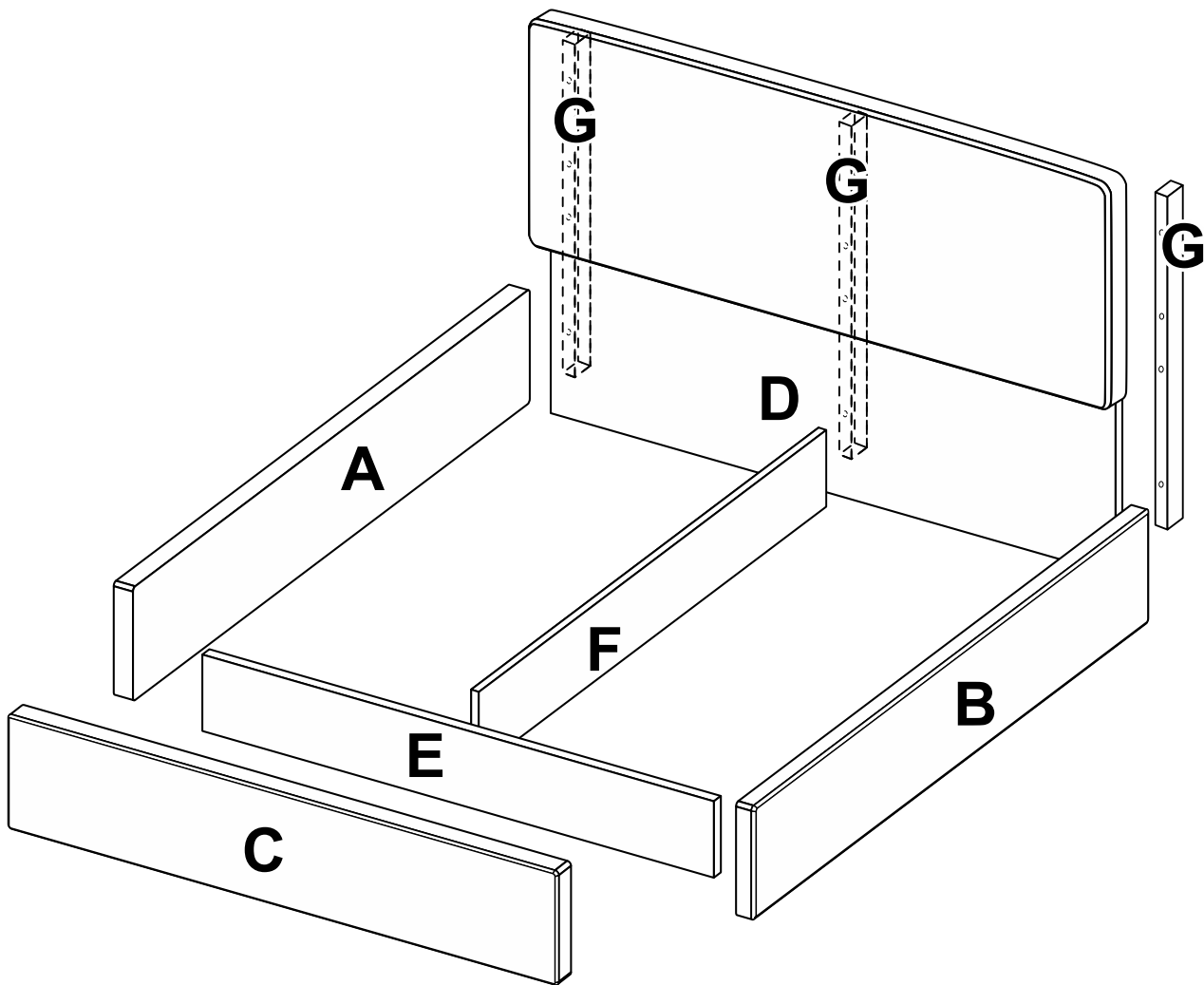

1.6 m

1.8 m

- A** - 2008 x 345 x 65 - **x 1**
* (2070)
- B** - 2008 x 345 x 65 - **x 1**
* (2070)
- C** - 1750 x 345 x 65 - **x 1**
- D** - 1800 x 1235 x 100 - **x 1**
- E** - 1616 x 230 x 18 - **x 1**
- F** - 1850 x 230 x 18 - **x 1**
- *** G** - 1024 x 45 x 25 - **x 3**

- A** - 2008 x 345 x 65 - **x 1**
* (2070)
- B** - 2008 x 345 x 65 - **x 1**
* (2070)
- C** - 1950 x 345 x 65 - **x 1**
- D** - 2000 x 1235 x 100 - **x 1**
- E** - 1816 x 230 x 18 - **x 1**
- F** - 1850 x 230 x 18 - **x 1**
- *** G** - 1024 x 45 x 25 - **x 3**

