

BED

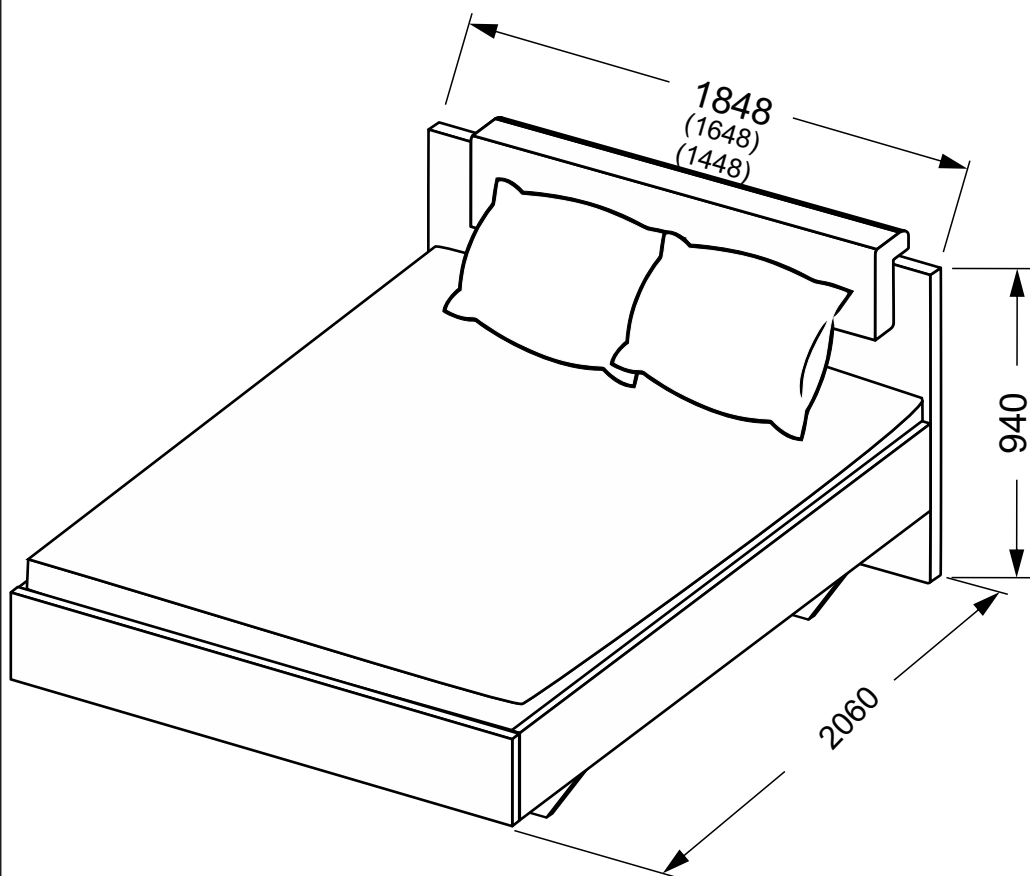

T9065
13-IZ-28

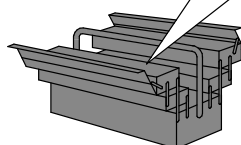
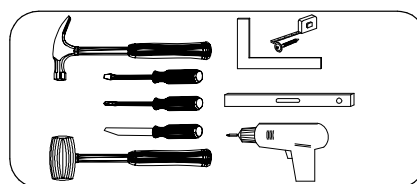
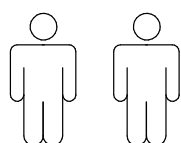

1

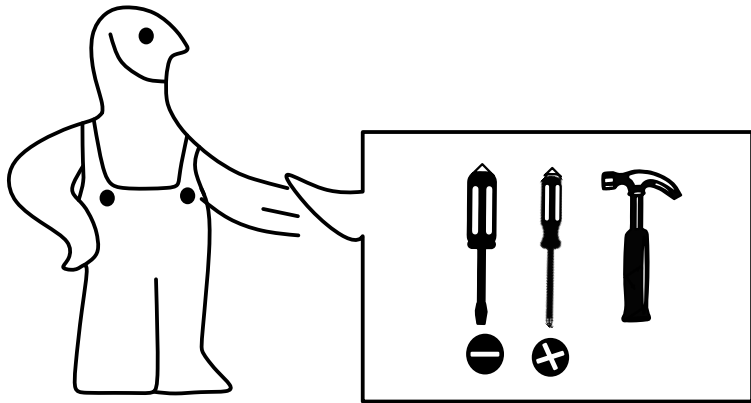

2

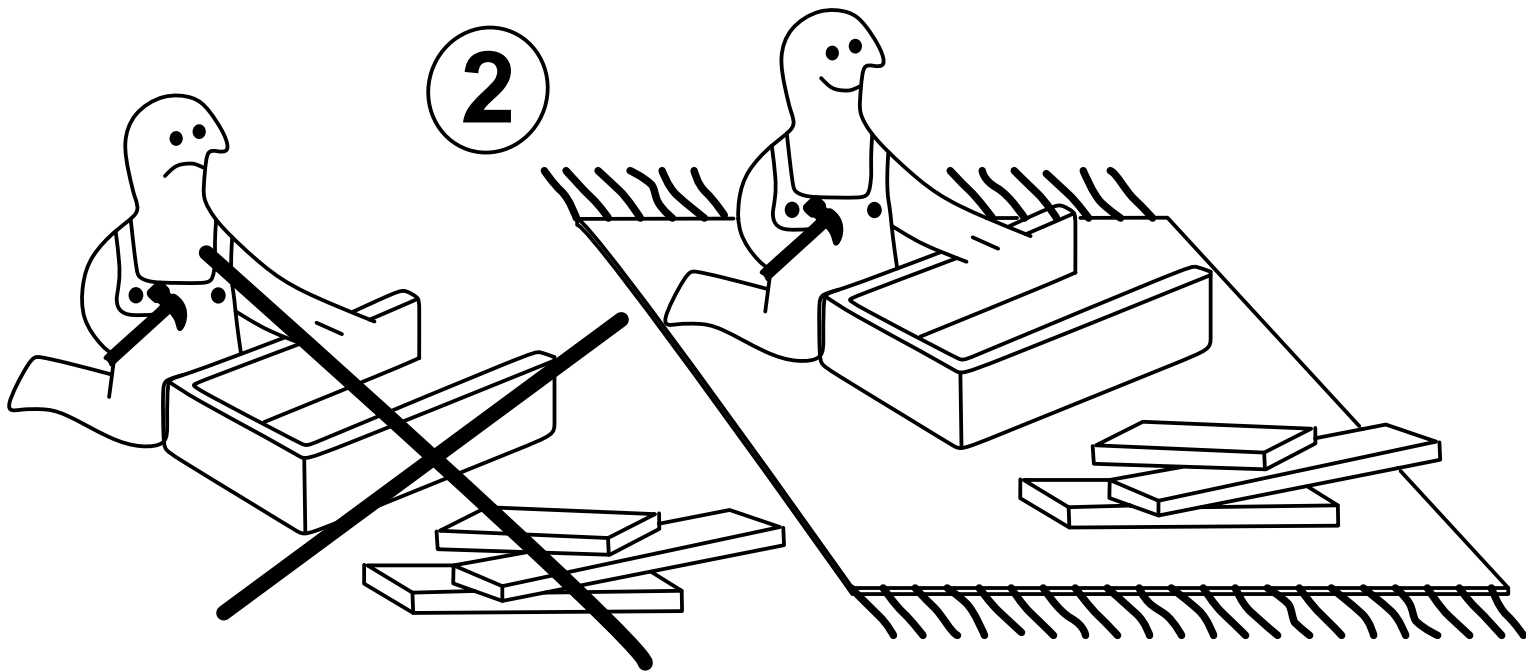

3



4

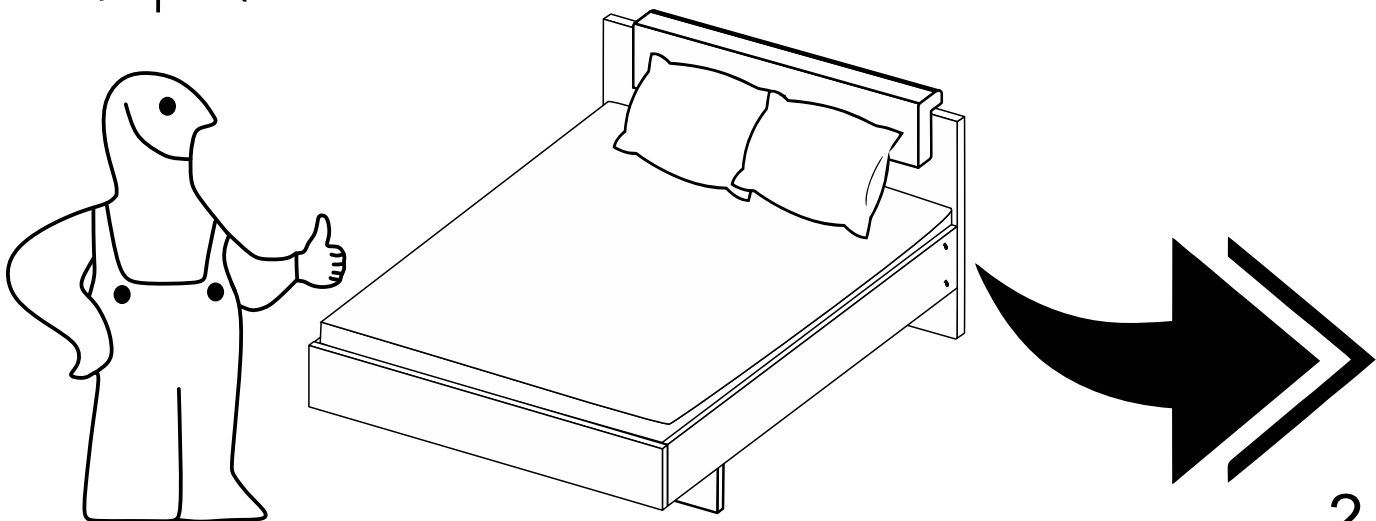

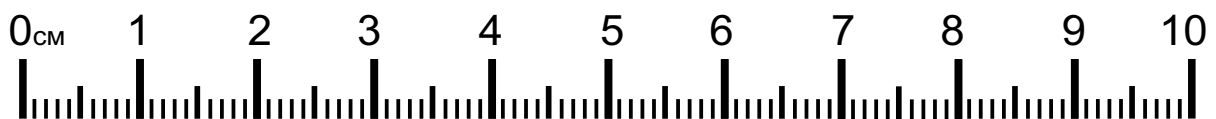
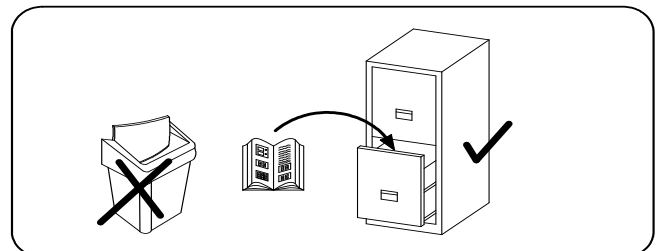
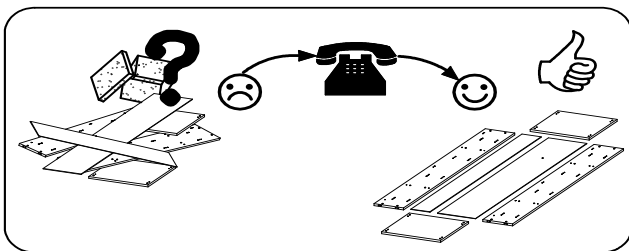
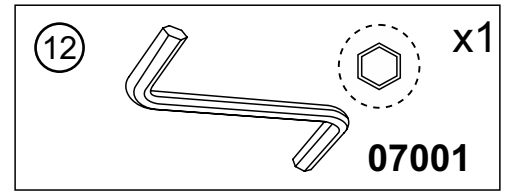
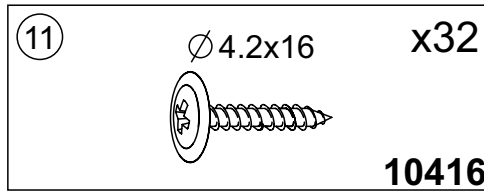
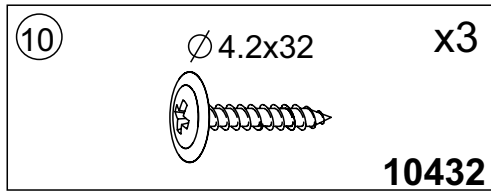
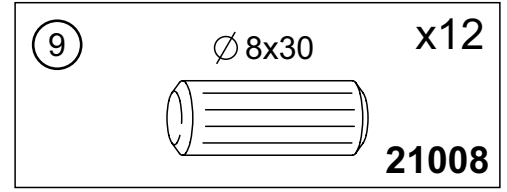
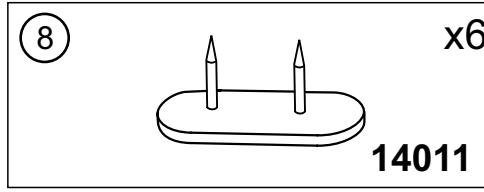
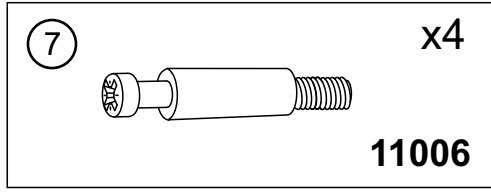
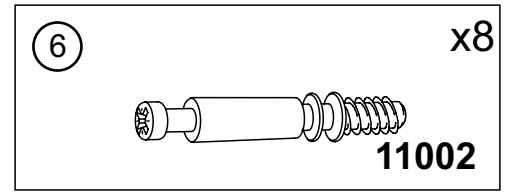
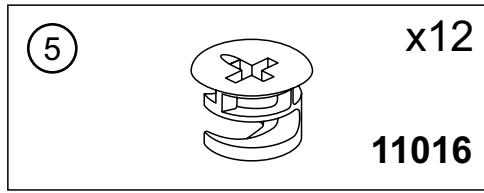
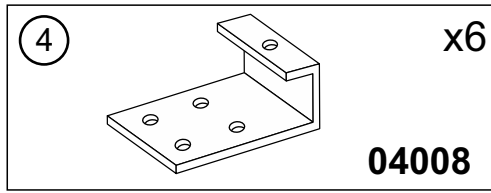
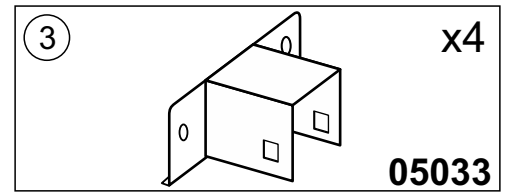
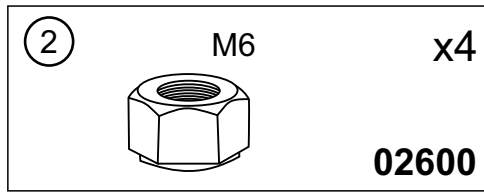
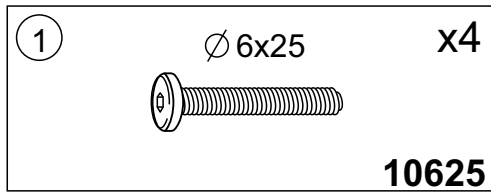

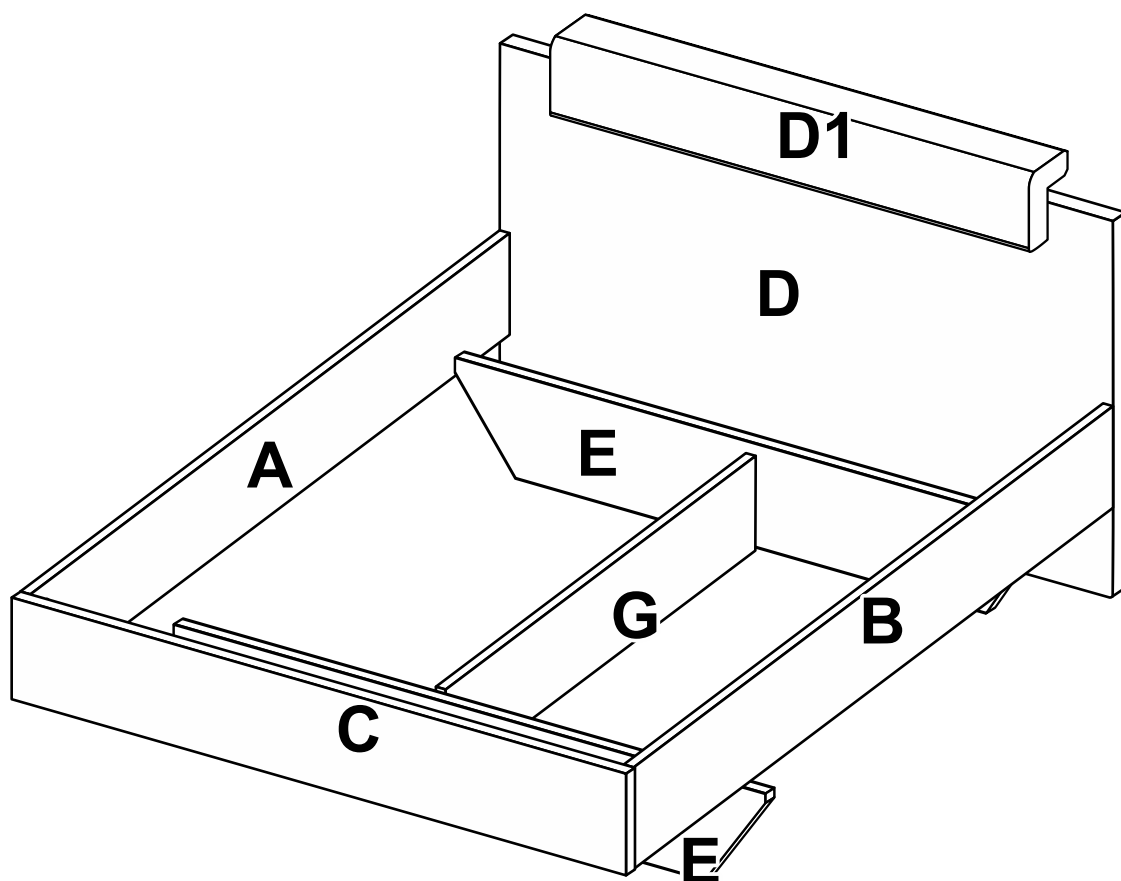

№ p.

№ p.

1.4 m

A	-	2008	x	210	x	16	-	x	1	3/3
B	-	2008	x	210	x	16	-	x	1	3/3
C	-	1449	x	210	x	16	-	x	1	3/3
D	-	1448	x	900	x	16	-	x	1	2/3
D1	-	1264	x	240	x	90	-	x	1	1/3
E	-	1616	x	270	x	16	-	x	2	2/3
G	-	1260	x	270	x	16	-	x	1	2/3

1.6 m

A	-	2008	x	210	x	16	-	x	1	3/3
B	-	2008	x	210	x	16	-	x	1	3/3
C	-	1649	x	210	x	16	-	x	1	3/3
D	-	1648	x	900	x	16	-	x	1	2/3
D1	-	1364	x	240	x	90	-	x	1	1/3
E	-	1616	x	270	x	16	-	x	2	2/3
G	-	1260	x	270	x	16	-	x	1	2/3

№ p.

1.8 m

A	-	2008	x	210	x	16	-	x	1	3/3
B	-	2008	x	210	x	16	-	x	1	3/3
C	-	1849	x	210	x	16	-	x	1	3/3
D	-	1848	x	900	x	16	-	x	1	2/3
D1	-	1564	x	240	x	90	-	x	1	1/3
E	-	1816	x	270	x	16	-	x	2	2/3
G	-	1260	x	270	x	16	-	x	1	2/3

