

Mirror Hugo 1000x700x19 mm

ASSEMBLY INSTRUCTION

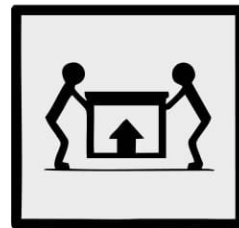
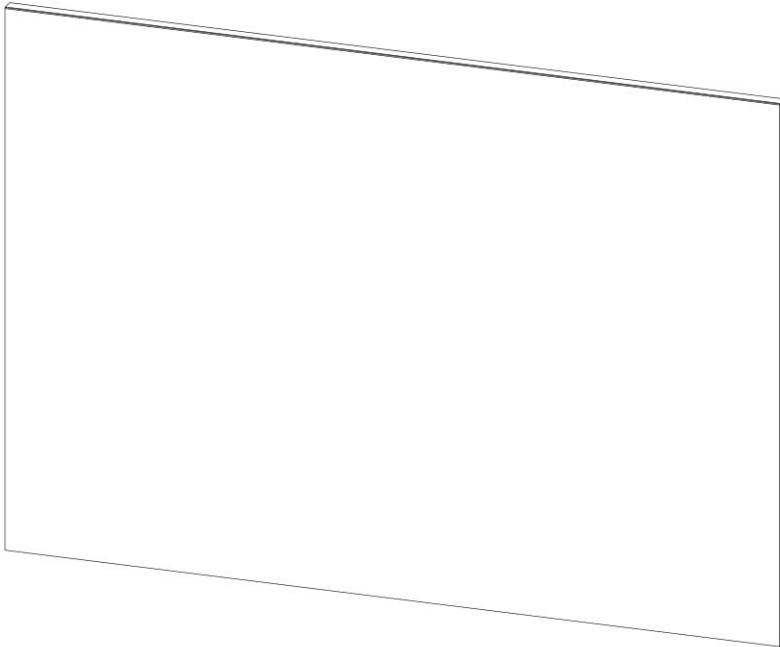

NOTE!

For all questions and complaints about this product, please contact the place of purchase of this product.



RULES FOR USE AND CARE OF FURNITURE

1. Use furniture only in dry rooms protected from the effects of weather conditions.
2. Install with suitable tools according to these assembly instructions.
3. Try to assemble as close to the location as possible.
4. The body is assembling in a horizontal position.
5. Before moving furniture, make sure that it is not loaded with items.

Caution: moving furniture may damage it.

When moving, hold on to vertical elements only; moving furniture by horizontal parts can break the product.

6. Overloading the furniture can damage it.
7. From time to time check the fittings and their correct position.
8. Wipe the furniture surface only with a slightly damp cloth or paper towels. Do not use chemical cleaning agents other than those specifically made for this.

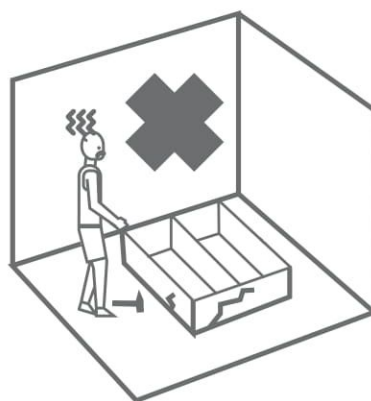
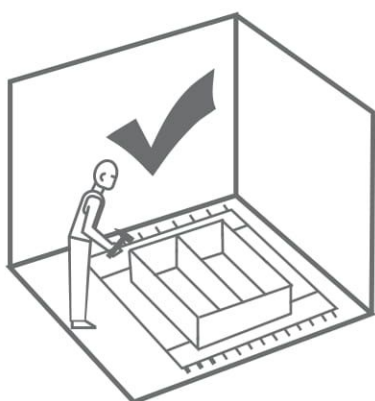
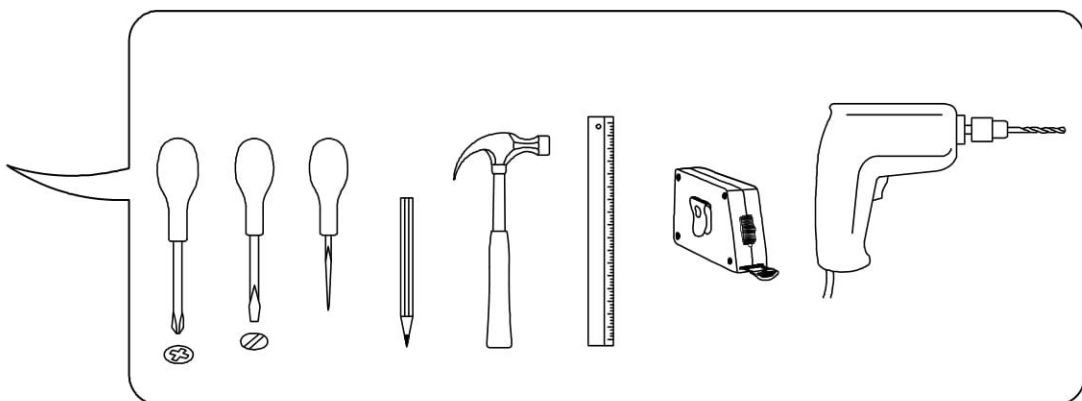

60-120 min

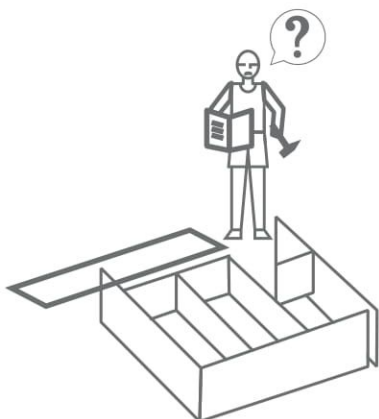
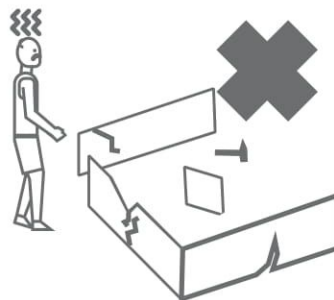
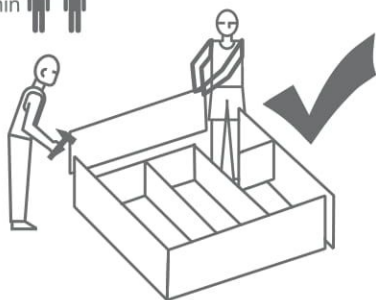

1

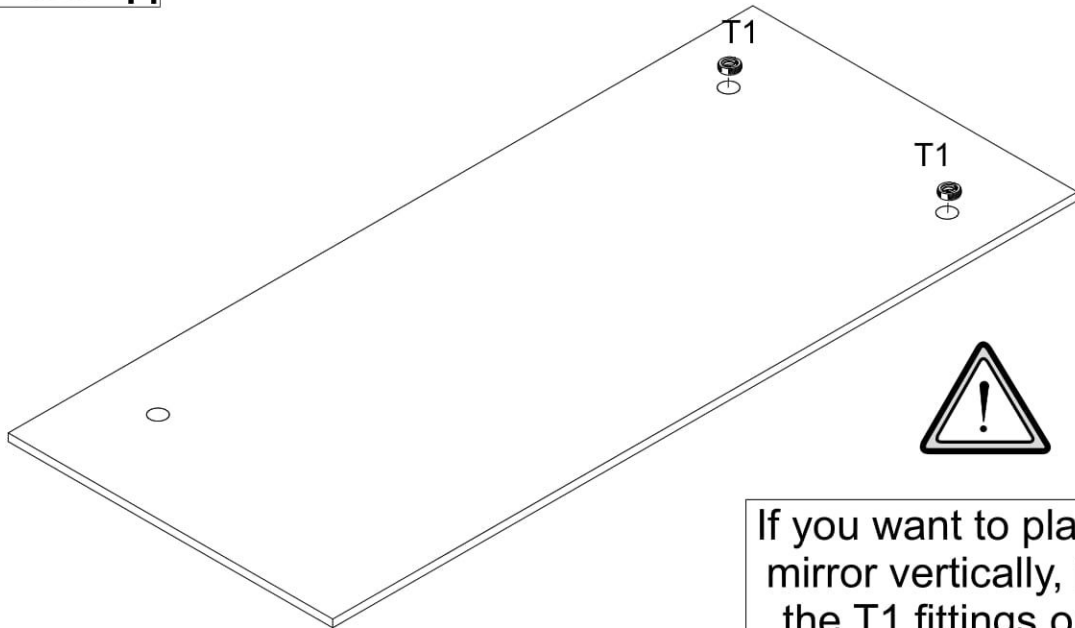
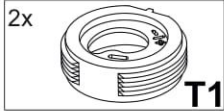

If you want to place the mirror vertically, install the T1 fittings on the shorter side.

2

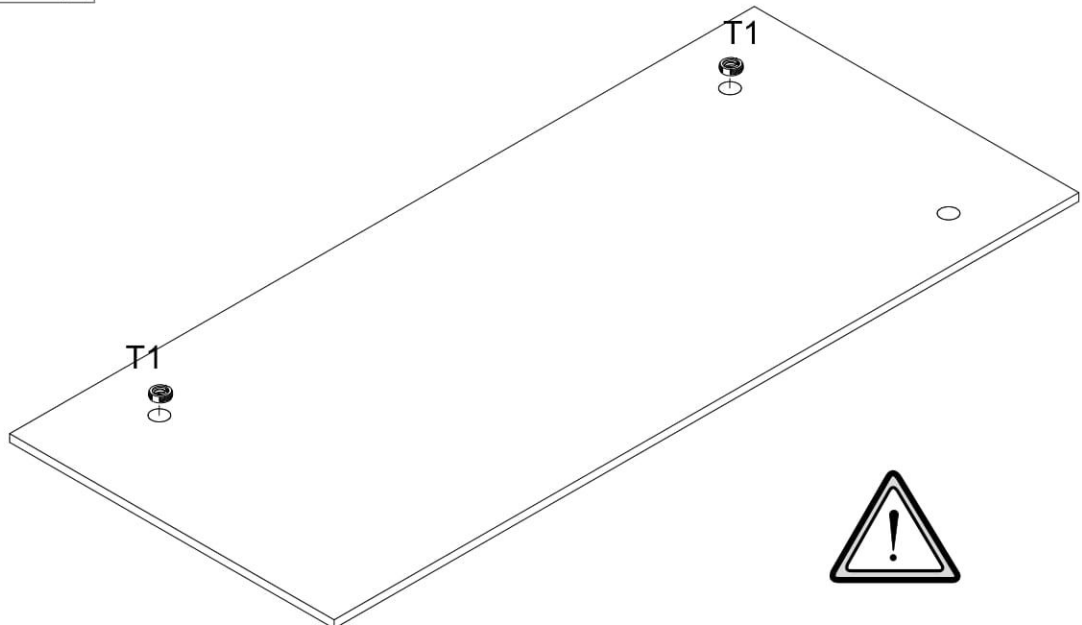
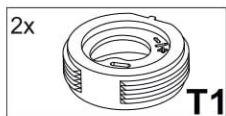

If you want to place the mirror horizontally, install the T1 fittings on the long side.

